

# Gutta Percha Obturation Device Instruction Manual

CE 0197

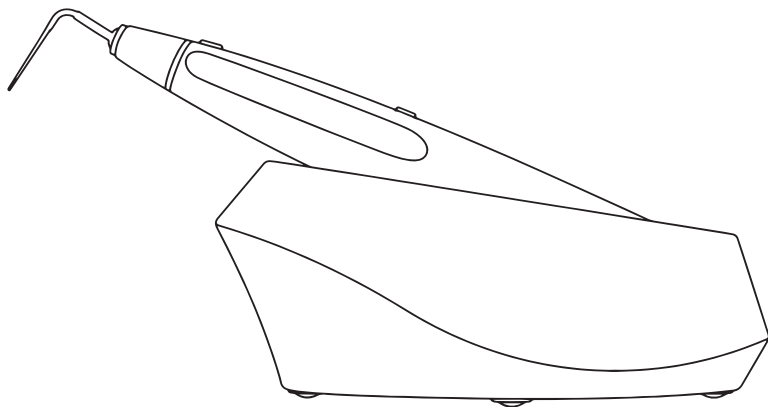

**Fi-P**

**Guilin Woodpecker Medical Instrument Co., Ltd.**

# Contents

Introduction -----	1
1 Product introduction-----	1
2 European authorized representative -----	6
3 Standard icons-----	6
4 Contraindications -----	7
5 Installation and disassembly method of accessories -----	7
6 Operation method-----	9
7 Charging instruction-----	9
8 Safety precautions -----	9
9 Cleaning, Disinfection, Sterilization and Maintenance	10
10 Troubleshooting -----	16
11 After-sales service-----	17
12 Environment protection -----	17
13 EMC-Declaration of conformity -----	17
14 Statement-----	21

# Introduction

Thank you for purchase Fi-P Heating and Packing Instrument developed by Guilin Woodpecker Medical Instrument Co., Ltd, a Hi-tech enterprise developing, manufacturing, and selling dental instruments. Woodpecker has excellent Quality Control System. To guarantee correct and safe operation, please read this Instruction Manual carefully before use. Depending on the level of risk involved, safety requirements are classed under the following indications:

- ⚠ Danger: (always referred to personal injury)
- ⚠ Warning: (referred to possible damage to property)

## 1 Product introduction

### 1.1 Intended use

It is used to provide heat to the Work Tip, cut the gutta-percha point, and soften and pressurize the gutta-percha. And the applied part is Work Tip.

### 1.2 Diagram of components and control buttons

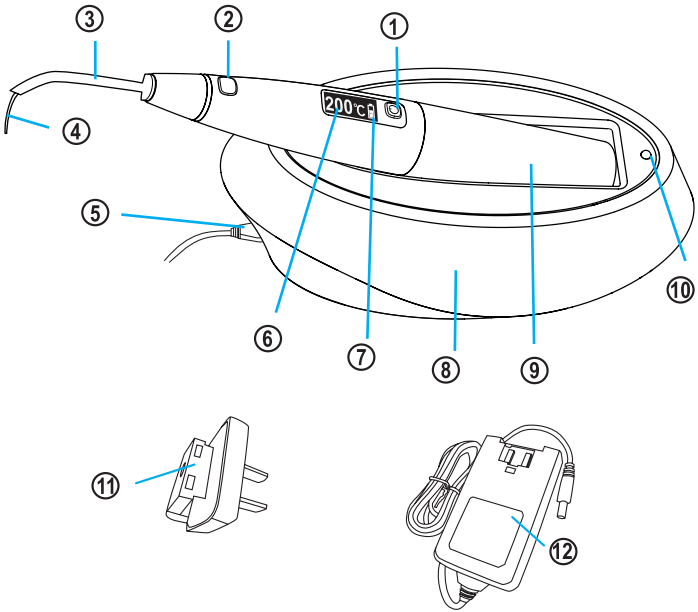

- |                                      |                        |
|--------------------------------------|------------------------|
| 1. "ON/OFF" button                   | 2. Heating button      |
| 3. Work Tip Protector                | 4. Work Tip            |
| 5. Connecting hole for power adapter | 6. Temperature Level   |
| 7. Battery level                     | 8. Charging base       |
| 9. Battery cartridge                 | 10. Charging indicator |
| 11. Power adapter plug               | 12. Power adapter unit |
| 1) "ON/OFF" button:                  |                        |

Under shutdown state, shortly press "ON/OFF" button to start the device.

Under shutdown state, long press "ON/OFF" button to start the device and change the direction of screen display, that is to say, the direction of display can be change to adapt to the operation in left hand or right hand.

Under ON state, long press "ON/OFF" button to shut down the device. (Time for long press is about 1s.)

**Note:** If there is no operation for 10 minutes, the Heating and Packing Instrument will automatically shut down.

Under ON state, shortly press "ON/OFF" button to change the preset temperature of Work Tip. The preset temperature will change to the next with the sequence 150°C→180°C→200°C→230°C after each press. And then go back to 150°C after short press at temperature of 230°C.



Figure 1 Preset temperature

### 2) Heating button:

Under the ON state, connect the Work Tip, and press Heating button to start heating. Release the Heating button to stop heating, followed by the fall of Work Tip temperature.

**Note:** If press and hold the Heating button for more than 10 seconds, the device will stop heating. If need to continue heating, please release the Heating button and press again.

### 3) Volume set

After power-on ,press "ON/OFF" button and "Heating" button simultaneously to enter the voice volume setting mode, then short press the "ON/OFF" button to select suitable voice volume, the last, short press the "Heating" button to exit the voice volume setting mode as shown in Figure2.



Figure2a Low volume    Figure2b Medium volume    Figure2c High volume

#### 4) Battery level:

The actual power of the battery is displayed in real time on the screen. When the battery is fully charged, the power of the OLED display is displayed as five grids. When the battery level is one grid, it indicates that the battery is low and needs to be charged in time. When the battery level is displayed as a space, it indicates that the battery is very low and needs to be charged immediately.

**Note:** During normal use, try not to let the battery level reduced to space status (completely no power) before charge, which will shorten the service life of battery.



#### **Warning:**

If the device has not been used for more than one month, the battery needs to be recharged. If the device is not in use for a long time, please be sure to charge it at least once a month to protect the battery. The service life of battery of Heating and Packing Instrument will be shortened when it is in a low battery state for a long time or when it leaves the charging base for a long time.

#### 5) Temperature Level:

When the temperature is preset, the display screen shows the preset temperature value. About 1s after the temperature preset, the OLED screen will display the real-time temperature of the Work Tip. When the Heating and Packing Instrument is in the heating state, the temperature indicator will simultaneously display the current temperature of the Work Tip.

#### 6) Charging base:

Firstly, connect the power adapter plug to the power adapter as shown in Figure 3. Then connect the power adapter to the power connecting hole on the charging base as shown in Figure 4 and connect the power adapter to a standard socket. Place the Heating and Packing Instrument correctly on the charging base as shown in Figure 5, so that the charging connector under the Heating and Packing Instrument can be reliably connected to the output connector of the charging base. When the Heating and Packing Instrument is properly connected to the charging base, the LED charging indicator on the base will be on constantly. If the LED is flashing or not lit, please check all the cables carefully.

There are charging status indicators on the charging base. When the Heating and Packing Instrument is not placed on the charging base, the indicator will flashes in yellow and green alternately. When the Heating

and Packing Instrument is placed on the charging base, if the charging is being charged, the yellow indicator will be on constantly. When the battery is full, the yellow indicator will be off and the green indicator will be on constantly.

**Notes:** After receiving the device, please charge it immediately. Before use, please be sure that battery is fully charged. When the device is fully charged, the battery level of the Heating and Packing Instrument led display screen is the highest. After the battery runs out, the time of battery charging takes at least 2 hours and 30 minutes.

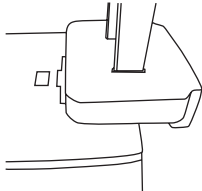

Figure 3 Installation of power adapter

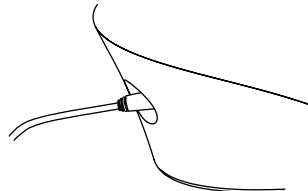

Figure 4 Connection to power supply

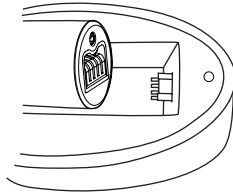

Figure 5 Charging

### 1.3 Device includes

1. Heating and Packing Instrument
2. Charging base
3. Power adapter with cord
4. Work Tips (The models are as shown in Table 2)
5. Work Tip Protector
6. Instruction Manual
7. Qualified Certification
8. Warranty card
9. Packing list

Model	Work Tip Size(mm)	Taper
WP4004	0.40	0.04
WP4504	0.45	0.04
WP5506	0.55	0.06

WP5508	0.55	0.08
--------	------	------

Table 2 Model of Work Tips

#### 1.4 Introduction and scope of application

##### 1.4.1 Features:

a) The display can be set to both right and left sides, to meet the needs of both left-hander and right-hander.

b) Cordless design for Heating and Packing Instrument effectively broadens the operation space.

c) Sensitive temperature control, simple display, and convenient operation; Press temperature setting button to set suitable working temperature.

d) Four preset temperatures are for option: 150°C, 180°C, 200°C, 230°C.

e) If there is no operation for 10 minutes, the Heating and Packing Instrument will automatically shut down.

##### 1.4.2 Scope of application:

Used in the root canal obturation stage in endodontic treatment.

#### 1.5 Product specifications

Size	Heating and Packing Instrument	23.8mm×158.3mm×23.8mm
	Charging base	75.5mm×149.7mm×62.6mm
Weight	Heating and Packing Instrument	80g
	Charging base	195g
	Power adapter	167g

#### 1.6 Technical parameters

Classification	Class II(AC/DC power adapter)	
Optional preset temperatures	150°C→180°C→200°C→230°C	
Time consumption for charging	About 2.5h	
Power supply	Input	AC100V-240V 50/60Hz 800mA
	Output	DC15V/1.6A
Battery capacity	Chargeable battery	2000mAh
Heater Rating	10W	

### 1.7 Environmental parameters

Temperature: +5°C ~ +40°C

Humidity: 30% ~ 75%

Air pressure: 70kPa ~ 106kPa

### 1.8 Storage and transport

1. The device should be handled carefully and lightly. Be sure that it is far from the vibration, and is installed or kept in a cool, dry, and ventilated place.

2. Do not store the device together with the articles that are combustible poisonous, caustic, or explosive.

3. The device should be stored in a room where the relative humidity is 10% ~ 93%, the air pressure is 70kPa ~ 106kPa, and the temperature is -20°C ~ +55°C.

4. Please avoid the device from strong shock or vibration during transport. And please handle it carefully.











5. Please do not mix the device with hazardous articles during transport.

6. Please avoid the device from sun, rain, and snow during transport.







## **2 European authorized representative**

**EC REP** MedNet EC-Rep GmbH  
Borkstrasse 10 · 48163 Muenster · Germany

## **3 Standard icons**

	Product serial number		Follow Instructions for Use
	Manufacturer		Date of manufacture
	Type B applied part		Class II device
	Power switch	<b>IPX0</b>	Ordinary equipment
	Used indoor only		Caution, hot surface
	Can be autoclaved	DC 15V	DC 15V



	CE marked product		
	Device complies with WEEE directive		
	Attention! Please refer to the accompanying documents.		
	Humidity limit for storage: 10% ~ 93%		
	Atmospheric pressure for storage: 70kPa ~ 106kPa		
	Temperature limit for storage: -20°C ~ +55°C		
	Authorised Representative in the EUROPEAN COMMUNITY		

## 4 Contraindications

1. People who are allergic to known natural latex and metals such as stainless steel, silver, copper, etc. are forbidden to use this device.
2. The patient with hemophilia is forbidden to use this device.
3. The patients with heart pacemaker are forbidden to use this device.
4. The dentists with heart pacemaker are forbidden to use this device.
5. Heart disease patients, pregnant women and children should be cautious to use the equipment.

## 5 Installation and disassembly method of accessories

### 5.1 Connection of power adapter

Connect the output point of power adapter to the charging base, and connect the input point to the socket that meets the standard of this power adapter. Please install in accordance with the procedures in Figure 3, Figure 4, and Figure 5. (Note: The installation in Figure 3 had been finished before delivery.)

### 5.2 Installation and removal of Work Tip

1. After turning off the power switch, you can directly pull the Work Tip off the Heating and Packing Instrument.
2. Place the used Work Tip in a certain container and disinfect it.
3. Select the desired work Work Tip and the hexagonal plug on the

Work Tip (as indicated by the red arrow in Figure 6). When installing the work Work Tip as shown in Figure 7, you can select the appropriate direction according to the usage to insert the Work Tip into the Heating and Packing Instrument.

4. Install the Work Work Tip Protector to the Work Tip as shown in Figure 8, to prevent scalding patient's mouth during operation.

5. Under ON state, if the Work Tip hasn't been installed or is in poor connection, there would be an error code on display screen as shown in Figure 9.

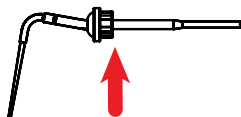

Figure 6 Work Tip

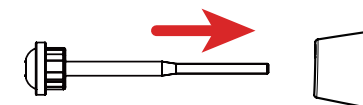

Figure 7 Installation of Work Tip

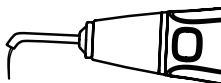

Figure 8 Installation of Work Tip Protector



Figure 9 Error code

### 5.3 Installation and replacement of battery

When replacing the battery, as shown in Figure 10, first rotate the battery barrel counterclockwise to remove the battery tube, then take the old battery out of the battery tube, replace it with a new one, and finally tighten the battery tube clockwise according to the corresponding thread.

**⚠ Warning:** When removing the battery, the screw under the battery barrel (pointed by the arrow in Figure 10) does not need to be unscrewed, just push the connector slightly inward to remove the battery. Improper replacement of lithium batteries may result in unacceptable risks, so replacement of lithium batteries requires trained personnel.

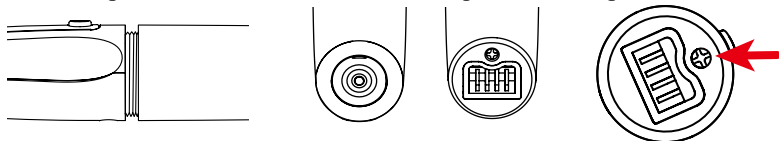

Figure 10 Replacement of battery

## 6 Operation method

1. According to the situation of patient, select suitable Work Tip and install it. When installing the Work Tip, chose a suitable angle to install the Work Tip.

 **Danger:**

Don't turn on the device when installing the Work Tip, to prevent scalding the user by mistakenly pressing the heating button.

2. After pressing the "ON/OFF" button, the display screen of Heating and Packing Instrument lights up and display the preheating temperature and power status.

3. According to the actual situation, lightly press the temperature setting button, and select suitable preheating temperature as per the instruction on display screen.

4. During operation, lightly press the heating button so as to heat up to the preset temperature, soften and pressurizing the gutta-percha with careful, continuous and stable motion with the help of vertical pressurizer.

**Note:** The continuous heating time on gutta-percha cannot exceed 4s, or there would be risk of scalding.

5. After operation, please clean, disinfect, and sterilize the Work Tip. The specific method is shown in Chapter 9.

## 7 Charging instruction

7.1 Use the corresponding charging base for this device. Connect the power adapter with the charging base, connect the power supply, and then correctly place the Heating and Packing Instrument into the charging base.

7.2 The battery used in this product has no memory and can be used at any time or charged at any time.

7.3 Before first use of this device, please charge it at least for 3 hours.

 **Warning:** Only unplug the adapter to disconnect from the network power.

## 8 Safety precautions

1. Do not polish the Work Tip.

2. Do not knock or scratch the Heating and Packing Instrument.

3. Keep the heating pressurizer, Work Tip, etc. under heating state

away from inflammable and explosive materials.

4. Please keep the device clean before and after operation. Before each use, please disinfect Work Tip and its accessories.

5. The product should be in strict accordance with relevant operation specifications of medical authority and relative regulations. The product can only be operated by trained doctors or technicians.

6. Do not install, remove, or replace the Work Tip under heating state. Please power off before replace the Work Tip.

7. The Work Tip must be correctly installed to prevent it from falling off.

8. When the Work Tip is bent or worn, it will cause uneven heating. The operator should replace the Work Tip in time according to the clinical conditions;

9. After operation, please turn off the power immediately.

Woodpecker is specialized in producing medical instrument. We are only responsible for the safety on the following conditions:

a) The maintenance, repair, and modification are made by the manufacturer or the authorized dealers.

b) The charged components are original of “Woodpecker” and operated according to instruction manual.

## **9 Cleaning, Disinfection, Sterilization and Maintenance**

The cleaning, disinfection and sterilization of Work Tip. Unless otherwise stated, it will be hereinafter referred to as “product”.



### **Warnings**

The use of strong detergent and disinfectant (alkaline pH>9 or acid pH <5) will reduce the life span of product. And in such cases, the manufacturer takes no responsibility. This product shall not be exposed to high temperature above 138°C.

### **9.1 Processing limit**

The product have been designed for a large number of sterilization cycles. The materials used in manufacture were selected accordingly. However with every renewed preparation for use, thermal and chemical stresses will result in ageing of the product. The maximum number of sterilizations for Work Tip is 100 times. And each time you carry out Cleaning; disinfection and sterilization, you must make corresponding

records. And each time you carry out cleaning and disinfection, you must make corresponding records

## 9.2 Initial processing

### 9.2.1 Processing principles

It is only possible to carry out effective sterilization after the completion of effective cleaning and disinfection. Please ensure that, as part of your responsibility for the sterility of products during use, only sufficiently validated equipment and product-specific procedures are used for cleaning/disinfection and sterilization, and that the validated parameters are adhered to during every cycle. Please also observe the applicable legal requirements in your country as well as the hygiene regulations of the hospital or clinic, especially with regard to the additional requirements for the inactivation of prions.

### 9.2.2 Post-operative treatment

The post-operative treatment must be carried out immediately, no later than 30 minutes after the completion of the operation. The steps are as follows:

1. Turn off the Heating Handpiece and allow it to stand on the base for 1 minutes to cool down to room temperature at the Work Tip;
2. Use a cotton swab or a clean soft cloth to remove the remaining Gutta-percha material from the Work Tip,
3. Dry the product with a clean, soft cloth and place it in a clean tray.

### 9.2.3 Preparation before cleaning

#### Steps

Tools: tray, clean and dry soft cloth.

1. Remove the Work Tip Protector from the handle and put it into a clean tray.
  2. Remove the Work Tip from the handle and place it in a clean tray.
  3. Wipe the Work Tip with a soft cloth until no dirt can be seen on the surface. Then dry it with a clean soft cloth and put them into a clean tray.
- Cleaning agent can be pure water.

#### Notes:

The pure water temperature should not exceed 45 °C, otherwise the protein will solidify and it is difficult to remove.

## 9.3 Cleaning

The cleaning should be performed no later than 24 hours after the operation. The cleaning adopt automated cleaning.

The cleaning procedure are as follows.

- 1) Pre-wash with pure water at 25 ° C for 3 minutes.
- 2) Clean with the condition recommended by the cleaning agent manufacturer for 5 minutes. For example the detergent use RUHOF ENDOZIME AW PLUS WITH APA, Dilution Ratio 1: 270, temperature 25°C. Clean for 5 minutes.
- 3) Rinse twice with pure water at 25 ° C for 1 minute each.

Notes:

a) The solution used the pure water and only freshly prepared solutions can be used.

b) During the use of cleaner, the concentration and time provided by manufacturer shall be obeyed.

c) The cleaner is proved to be valid by CE certification in accordance with EN ISO 15883.

d) The cleaning procedure is suitable for the product, and the irrigating period is sufficient.

#### 9.4 Disinfection

Disinfection must be performed no later than 2 hours after the cleaning phase. Automated disinfection is preferred if conditions permit.

For the thermal disinfection here, the temperature is 93 ° C, the time is 5 min, and A0 > 3000.

Cleaning and disinfecting steps by using Washer-disinfector

1. Carefully place the product into the disinfection basket. Fixation of product is needed only when the product is removable in the device. The product is not allowed to contact each other.

2. Start the program.

3. After the program is finished, remove the product from the washer-disinfector, inspect (refer to section “Inspection and Maintenance”) and packaging (refer to chapter “Packaging”). Dry the product repeatedly if necessary (refer to section “Drying”).

The intrinsic suitability of the product for effective cleaning and disinfection using the above automated cleaning and disinfection procedures was verified by a certified facility.

Notes:

a) Before use the washer-disinfector, you must carefully read the operating instructions provided by the equipment manufacturer to familiarize yourself with the disinfection process and precautions.

b) With this equipment, cleaning, disinfection and drying will be carried out together.

c) Only pure water with a small amount of microorganisms (<10 cfu/ml) can be used for all rinsing steps. (For example, pure water that is in accordance with the European Pharmacopoeia or the United States Pharmacopoeia).

d) The air used for drying must be filtered by HEPA.

e) Regularly repair and inspect the disinfectant.

### 9.5 Drying

If your cleaning and disinfection process does not have an automatic drying function, dry it after cleaning and disinfection.

#### Methods

1) Spread a clean white paper (white cloth) on the flat table, point the product against the white paper (white cloth), and then dry the product with filtered dry compressed air (maximum pressure 3 bar). Until no liquid is sprayed onto the white paper (white cloth), the product drying is completed.

2) It can also be dried directly in a medical drying cabinet (or oven). The recommended drying temperature is 80°C~120°C and the time should be 15~40 minutes.

#### Notes:

a) The drying of product must be performed in a clean place.

b) The drying temperature should not exceed 138 °C;

c) The equipment used should be inspected and maintained regularly.

### 9.6 Inspection and maintenance

In this chapter, we only check the appearance of the product. After inspection, ensure that there is no problem.

9.6.1 Check the product. If there is still visible stain on the product after cleaning/ disinfection, the entire cleaning/disinfection process must be repeated.

9.6.2 Check the product. If it is obviously damaged, smashed, detached, corroded, it must be scrapped and not allowed to continue to be used.

9.6.3 Check the product. If the accessory is found to be damaged, please replace it before use. And the new accessory for replacement must be cleaned, disinfected and dried.

9.6.4 If the number of times of the product reaches the specified number of times, please replace it in time.

## 9.7 Packaging

Install the disinfected and dried product and quickly package it in a medical sterilization bag (or special holder, sterile box).

Notes:

- a) The package used conforms to ISO 11607;
- b) It can withstand high temperature of 138 °C and has sufficient steam permeability;
- c) The packaging environment and related tools must be cleaned regularly to ensure cleanliness and prevent the introduction of contaminants;
- d) Avoid contact with parts of different metals when packaging.

## 9.8 Sterilization

Use only the following steam sterilization procedures (fractional pre-vacuum procedure\*) for sterilization, and other sterilization procedures are not recommended:

1. The steam sterilizer complies with EN13060 or is certified according to EN 285 to comply with EN ISO 17665;
2. The sterilization time is 5 minutes at a temperature of 134°C and a pressure of 2.0 bar ~ 2.3 bars.

Verification of the fundamental suitability of the products for effective steam sterilization was provided by a verified testing laboratory.

Notes:

- a) Only the product that have been effectively cleaned and disinfected are allowed to be sterilized;
- b) Before using the sterilizer for sterilization, read the Instruction Manual provided by the equipment manufacturer and follow the instructions.
- c) Do not use hot air sterilization and radiation sterilization as this may result in damage to the product;
- d) Please use the recommended sterilization procedures for sterilization. It is not recommended to sterilize with other sterilization procedures such as ethylene oxide, formaldehyde and low temperature plasma sterilization. The manufacturer assumes no responsibility for the procedures that have not been recommended. If you use the sterilization procedures that have not been recommended, please adhere to related effective standards and verify the suitability and effectiveness.

\* Fractional pre-vacuum procedure = steam sterilization with repetitive pre--vacuum. The procedure used here is to perform steam sterilization



through three pre-vacuums.

## 9.9 Storage

9.9.1 Store in a clean, dry, ventilated, non-corrosive atmosphere with a relative humidity of 10% to 93%, an atmospheric pressure of 70KPa to 106KPa, and a temperature of -20 °C to +55 °C;

9.9.2 After sterilization, the product should be packaged in a medical sterilization bag or a clean sealing container, and stored in a special storage cabinet. The storage time should not exceed 7 days. If it is exceeded, it should be reprocessed before use.

Notes:

a) The storage environment should be clean and must be disinfected regularly;

b) Product storage must be batched and marked and recorded.

## 9.10 Transportation

1. Prevent excessive shock and vibration during transportation, and handle with care;

2. It should not be mixed with dangerous goods during transportation.

3. Avoid exposure to sun or rain or snow during transportation.

9.11 The cleaning and disinfection of main unit and charging base are as follows.

 Warnings: Do not clean the main unit and charging base with ultrasound cleaning machine.

- Before each use, wipe the surface of the main unit and charging base with a soft cloth or paper towel soaked in 75% medical alcohol. Repeat the wipe for at least 3 times.

- After each use, wipe the surface of the main unit and charging base with a soft cloth soaked in clean water (pure water) or a clean disposable wipe. Repeat the wipe for at least 3 times.

## 9.12 Daily maintenance

1. When the device is not used, please turn off the power and unplug the power supply plug.

2. If the Heating and Packing Instrument is in a low battery state for a long time, the service life of battery will be shortened. Please charge it in time if the battery level is low.

3. When the device is not used, please charge it for 1 hour once a month.

### 9.13 Repair of device

This product does not contain self-repairing spare parts. If there is any abnormality in the equipment, please contact our company for maintenance and do not disassemble without authorization. With our company's consent, we will provide circuit diagrams, component part lists, descriptions, calibration instructions to assist to SERVICE PERSONNEL in parts repair.

## 10 Troubleshooting

Fault	Cause	Solution
No indications, no response	<ol style="list-style-type: none"><li>1. Inadequate battery power</li><li>2. Battery is damaged.</li><li>3. The charging interface is short-circuited, causing the lithium battery to enter a protection state;</li><li>4. Heating and Packing Instrument is damaged.</li></ol>	<ol style="list-style-type: none"><li>1. Connect to power supply to charge. / Replace the battery.</li><li>2. Replace the battery.</li><li>3. Remove the substance that causes the short circuit, put the device into the charging base to charge, and then the device will return to normal;</li><li>4. Contact local distributor or manufacturer.</li></ol>
Automatic shutdown	If there is no operation for 10 minutes, the device will automatic powers off.	Reboot
Work Tip works abnormally	<ol style="list-style-type: none"><li>1. The Work Tip is damaged.</li><li>2. Malfunction of main unit</li></ol>	<ol style="list-style-type: none"><li>1. Replace the Work Tip</li><li>2. Send it to the repair center.</li></ol>
Charging failure after connecting to power supply	<ol style="list-style-type: none"><li>1. The power supply is not correctly connected;</li><li>2. The power supply is damaged, or the specification doesn't match.</li><li>3. There are impurities on the contact thimble of charging base.</li></ol>	<ol style="list-style-type: none"><li>1. Unplug and reconnect.</li><li>2. Replace the battery.</li><li>3. Wipe the thimble with alcohol, dry it, and reconnect.</li></ol>

The service time after each charging is shortened	The battery ages and the battery capacity become smaller.	Contact local distributor or manufacturer to buy new batteries for replacement.
OPEN code appears on display screen	1. The Work Tip is damaged. 2. The Work Tip is not installed. 3. The Work Tip is not well installed.	1. Replace the Work Tip. 2. Install the Work Tip. 3. Unplug the Work Tip, and reconnect.

If the problem still cannot be solved, please contact your local dealer or our company.

## 11 After-sales service

Since the date of sales, if the device cannot work normally for quality problem, our company will be responsible for the repair of device during the warranty period. Please refer to the Warranty Card for warranty period and warranty scope.

## 12 Environment protection

The device does not contain any harmful ingredients. It can be handled or destroyed in accordance with the relevant local regulations.

### Note:

1) Without Woodpecker agreement and authorization, private modification of device may result in the electromagnetic compatibility problem of that device or other devices.

2) The design and test of Heating and Packing Instrument complies with the related operation regulations of electromagnetic compatibility.

## 13 EMC-Declaration of conformity

The device has been tested and homologated in accordance with EN 60601-1-2 for EMC. This does not guarantee in any way that this device will not be effected by electromagnetic interference Avoid using the device in high electromagnetic environment.

### Technical Description Concerning Electromagnetic Emission

**Table 1: Declaration - electromagnetic emissions**

<b>Guidance and manufacturer's declaration - electromagnetic emissions</b>		
The model Fi-P is intended for use in the electromagnetic environment specified below. The customer or the user of the model Fi-P should assure that it is used in such an environment.		
Emissions test	Compliance	Electromagnetic environment - guidance
RF emissions CISPR 11	Group 1	The model Fi-P uses RF energy only for its internal function. Therefore, its RF emissions are very low and are not likely to cause any interference in nearby electronic equipment.
RF emissions CISPR11	Class B	The model Fi-P is suitable for used in all establishments, including domestic establishments and those directly connected to the public low-voltage power supply network that supplies buildings used for domestic purposes.
Harmonic emissions IEC 61000-3-2	Class A	
Voltage fluctuations / flicker emissions IEC 61000-3-3	Complies	

## Technical Description Concerning Electromagnetic Immunity

**Table 2: Guidance & Declaration - electromagnetic immunity**

<b>Guidance &amp; Declaration — electromagnetic immunity</b>			
The model Fi-P is intended for use in the electromagnetic environment specified below. The customer or the user of the model Fi-P should assure that It is used in such an environment.			
Immunity test	IEC 60601 test level	Compliance level	Electromagnetic environment - guidance
Electrostatic discharge (ESD) IEC 61000-4-2	±8kV contact ±2, ±4, ±8, ±15kV air	±8kV contact ±2, ±4, ±8, ±15kV air	Floors should be wood, concrete or ceramic tile. If floors are covered with synthetic material, the relative humidity should be at least 30 %.
Electrical fast transient/burst IEC 61000-4-4	±2kV for power supply lines ±1kV for Input/output lines	±2kV for power supply lines	Mains power quality should be that of a typical commercial or hospital environment.

Surge IEC 61000-4-5	$\pm 0.5, \pm 1\text{kV}$ line to line $\pm 0.5, \pm 1, \pm 2\text{kV}$ line to earth	$\pm 0.5, \pm 1\text{kV}$ line to line $\pm 0.5, \pm 1, \pm 2\text{kV}$ line to earth	Mains power quality should be that of a typical commercial or hospital environment.
Voltage dips, short interruptions and voltage variations on power supply input lines IEC 61000-4-11	<5 % UT (>95% dip in UT.) for 0.5 cycle <5 % UT (>95% dip in UT.) for 1 cycle 70% UT (30% dip in UT) for 25 cycles <5% UT (>95 % dip in UT) for 250 cycles	<5 % UT (>95% dip in UT.) for 0.5 cycle <5 % UT (>95% dip in UT.) for 1 cycle 70% UT (30% dip in UT) for 25 cycles <5% UT (>95 % dip in UT) for 250 cycles	Mains power quality should be that of a typical commercial or hospital environment. If the user of the models Fi-P requires continued operation during power mains interruptions, it is recommended that the models Fi-P be powered from an uninterruptible power supply or a battery.
Power frequency (50/60 Hz) magnetic field IEC 61000-4-8	30A/m	30A/m	Power frequency magnetic fields should be at levels characteristic of a typical location in a typical commercial or hospital environment.
NOTE UT is the a.c. mains voltage prior to application of the test level.			

**Table 3: Guidance & Declaration - electromagnetic immunity concerning Conducted RF & Radiated RF**

<b>Guidance &amp; Declaration - Electromagnetic immunity</b>			
The model Fi-P is intended for use in the electromagnetic environment specified below. The customer or the user of the models Fi-P should assure that it is used in such an environment.			
Immunity test	IEC 60601 test level	Compliance level	Electromagnetic environment - guidance

Conducted RF IEC 61000-4-6 Conducted RF IEC 61000-4-6 Radiated RF IEC 61000-4-3	3 Vrms 150 kHz to 80 MHz 6 Vrms ISM frequency band 3 V/m 80 MHz to 2.7 GHz	3V 6V 3V/m	Portable and mobile RF communications equipment should be used no closer to any part of the models Fi-P, including cables, than the recommended separation distance calculated from the equation applicable to the frequency of the transmitter. Recommended separation distance $d=1.2 \times P^{1/2}$ $d=2 \times P^{1/2}$ $d=1.2 \times P^{1/2}$ 80 MHz to 800 MHz $d=2.3 \times P^{1/2}$ 800 MHz to 2.7 GHz where P is the maximum output power rating of the transmitter In watts (W) according to the transmitter manufacturer and d Is the recommended separation distance in meters (m). Field strengths from fixed RF transmitters, as determined by an electromagnetic site survey,a should be less than the compliance level in each frequency range.b Interference may occur In the vicinity of equipment marked with the following symbol:
--	---	------------------	---

NOTE 1 At 80 MHz end 800 MHz. the higher frequency range applies.

NOTE 2 These guidelines may not apply in all situations. Electromagnetic propagation is affected by absorption and reflection from structures, objects and people.

a Field strengths from fixed transmitters, such as base stations for radio (cellular/cordless) telephones and land mobile radios, amateur radio, AM and FM radio broadcast and TV broadcast cannot be predicted theoretically with accuracy.

To assess the electromagnetic environment due to fixed RF transmitters, an electromagnetic site survey should be considered. If the measured field strength in the location in which the model Fi-P is used exceeds the applicable RF compliance level above, the model Fi-P should be observed to verify normal operation. If abnormal performance is observed, additional measures may be necessary, such as reorienting or relocating the model Fi-P.

b Over the frequency range 150 kHz to 80 MHz, field strengths should be less than 3V/m.

**Table 4: Recommended separation distances between portable and mobile RF communications equipment and the model Fi-P**

<b>Recommended separation distances between portable and mobile RF communications equipment and the model Fi-P</b>			
The model Fi-P is intended for use in electromagnetic environment in which radiated RF disturbances is controlled. The customer or the user of the model Fi-P can help prevent electromagnetic interference by maintaining a minimum distance between portable and mobile RF communications equipment (transmitters) and the model Fi-P as recommended below, according to the maximum output power of the communications equipment.			
Rated maximum output power of transmitter W	Separation distance according to frequency of transmitter m		
	150kHz to 80MHz $d=1.2 \times P^{1/2}$	80MHz to 800MHz $d=1.2 \times P^{1/2}$	800MHz to 2,7GHz $d=2.3 \times P^{1/2}$
0,01	0.12	0.12	0.23
0,1	0.38	0.38	0.73
1	1.2	1.2	2.3
10	3.8	3.8	7.3
100	12	12	23
For transmitters rated at a maximum output power not listed above, the recommended separation distance d in meters (m) can be estimated using the equation applicable to the frequency of the transmitter, where P is the maximum output power rating of the transmitter in watts (W) accordable to the transmitter manufacturer. NOTE 1 At 80 MHz and 800 MHz. the separation distance for the higher frequency range applies. NOTE 2 These guidelines may not apply in all situations. Electromagnetic propagation is affected by absorption and reflection from structures, objects and people.			

## 14 Statement

Woodpecker reserves the right to change the design of the equipment, the technique, fittings, instruction manual and the content of the original packing list at any time without further notice. The pictures are only for reference. The final interpretation rights belong to Guilin Woodpecker Medical Instrument Co., Ltd.

Scan and Login website  
for more information



Guilin Woodpecker Medical Instrument Co., Ltd.  
Information Industrial Park, Guilin National High-Tech  
Zone, Guilin, Guangxi, 541004 P. R. China  
Sales Dept.: +86-773-5873196  
[Http://www.glwoodpecker.com](http://www.glwoodpecker.com)  
E-mail: [woodpecker@glwoodpecker.com](mailto:woodpecker@glwoodpecker.com)



MedNet EC-Rep GmbH  
Borkstrasse 10 · 48163 Muenster · Germany

ZMN-SM-039 V1. 4-20220419