

# 3Shape TRIOS 3 MOVE and MOVE+

## Safety and Setup Guide

Intraoral 3D scans



Models S1A-9, S1A-10, S1A-11, S1A-12, S1A-21, S1A-22

July 2019

3shape 

|                |     |
|----------------|-----|
| ENGLISH        | 2   |
| DEUTSCH        | 11  |
| FRANÇAIS       | 21  |
| ESPAÑOL        | 31  |
| ITALIANO       | 41  |
| PORTUGUÊS (BR) | 51  |
| EESTI KEEL     | 61  |
| NEDERLANDS     | 70  |
| SVENSKA        | 80  |
| SUOMI          | 89  |
| DANSK          | 98  |
| NORSK          | 108 |
| ΕΛΛΗΝΙΚΑ       | 117 |
| ROMÂNĂ         | 128 |
| ČESKY          | 138 |
| HRVATSKI       | 147 |
| MAGYAR         | 156 |
| БЪЛГАРСКИ      | 166 |
| LIETUVIŲ       | 177 |
| LATVISKI       | 186 |
| POLSKA         | 195 |
| РУССКИЙ        | 205 |
| 한국어            | 216 |
| انگلیسی        | 225 |
| العربية        | 234 |
| TÜRKÇE         | 243 |
| 繁體中文           | 252 |
| ไทย            | 261 |

# Table of Contents – TRIOS 3 MOVE+ Safety and Setup Guide

|  |    |
|--|----|
| 1. Dear Customer .....                             | 2  |
| 2. Conformity .....                                | 2  |
| 3. General Information .....                       | 2  |
| 4. Description of TRIOS .....                      | 3  |
| 5. Safety and Warnings .....                       | 5  |
| 6. Cleaning, Disinfection, and Sterilization ..... | 8  |
| 7. Disposal .....                                  | 10 |
| 8. Technical Maintenance .....                     | 10 |
| 9. Environmental Considerations .....              | 10 |
| 10. Consumable Accessories .....                   | 10 |
| 11. Vigilance .....                                | 10 |
| 12. Sponsors .....                                 | 10 |

## 1. Dear Customer

Thank you for purchasing your TRIOS® from 3Shape TRIOS.

The TRIOS system enables you to perform and digitally save oral scans of a patient's teeth for use in dental CAD/CAM systems.

This TRIOS safety and setup guide describes safety precautions, warnings, and considerations related to your TRIOS system. For step by step instructions regarding configuration, and operation of TRIOS, please refer to the online help.

Before assembling or using TRIOS, please carefully read and follow the instructions in this safety and setup guide and in the online help system. Please always keep this safety and setup guide near the system.

Please observe all safety information and warnings to prevent personal injury, material damage or damage to your TRIOS system.

Thank you,

3Shape Trios A/S

## 2. Conformity

This manual is published by 3Shape TRIOS A/S, who reserves the right to improve and modify the contents without prior notice. Modifications will, however, be published in future editions. All rights reserved.

TRIOS is a trademark of 3Shape TRIOS A/S.

Products manufactured by 3Shape TRIOS A/S, Holmens Kanal 7, 1060 Copenhagen K, Denmark.

### Declaration of Conformity (EU):





3Shape TRIOS A/S hereby declares that the TRIOS observes the provisions of: MDD 93/42/EEC with amendments until Directive 2007/47/EEC, 2011/65/EEC RoHS Directive, 2005/20/EEC Packaging and Packaging Waste Directive and 2002/96/EEC Waste electrical and electronic equipment (WEEE), and is in compliance with the following standards: EN (IEC) 60601-1, EN (IEC) 60601-1-1, EN (IEC) 60601-1-2, EN (IEC) 62471.

## 3. General Information













|  |   |
|--|---|
|  | <p><b>CAUTION</b><br/><b>Be sure to observe all warnings!</b></p> <p>Please observe all safety information and warnings to prevent personal injury, material damage or damage to your TRIOS system. Safety information and warnings are highlighted in this guide using the words WARNING, CAUTION or NOTICE.</p> |
|--|---|











## 3.1 About this Document – Symbols

The symbols used in this document imply the following:

|   |  |
|---|--|
|  | <p><b>WARNING</b></p> <p>Warnings regarding situations where a medium risk of injury to persons exists if the information is not observed.</p>   |
|  | <p><b>CAUTION</b></p> <p>Safety information where hazards such as: slight risk of injury to persons, risk of property damage, damage to the system exist if the information is not observed.</p> |
|  | <p><b>IMPORTANT NOTICE</b></p> <p>Important information that is not a warning/caution but must be strictly observed.</p>   |
|  | <p><b>TIPS</b></p> <p>Hints, tips, additional information to support optimal operation of the system.</p>  |

## 3.2 Legend of Labels and symbols

|   |  |
|---|--|
|    | Year of manufacture (EN/ISO 15223-1)                       |
|    | Company and address (EN/ISO 15223-1)                       |
|    | General warning – caution (ISO 7010-W001, black on yellow) |
|    | Type BF equipment (IEC 60417-5333)                         |
|    | WEEE Product disposal symbol (Directive 2002/96/EC)        |
|  | Caution (ISO 7000-0434A)                                   |
|  | CE marking   |
|  | Lot number   |
|  | Serial Number (EN/ISO 15223-1)                             |
|  | Consult instructions for use (EN/ISO 15223-1)              |
|  | AC (IEC 60417-5032)  |
|  | Protective Earth (IEC 60417-5019)                          |

|   |  |
|---|--|
|           | Warning – dangerous voltage (IEC 60878) (ISO 3864-B3.6, black on yellow)   |
|          | Expiry Date (EN/ISO 15223-1)   |
|          | Standby (IEC5009)  |
| <b>LAN</b>  | Local area network, ethernet connector (RJ45)  |
|          | Refer to instruction manual / booklet (ISO 7010-M002, blue).   |
| Scanner  | Connection point for handheld scanner; the scanner has a type BF applied part.   |
|          | Identifies the protection tip  |
|          | Identifies the calibration tip   |
|          | Warning following IEC 62471-2 (black on yellow): Possibly hazardous optical radiation emitted from this product. Do not stare at operating lamp. Under real circumstances (for exposure time, eye pupils, observation distance), it is assumed that no endangerment to the eye exists. The color scanners are risk group 2, the monochrome scanners are risk group “exempt”. |
|          | The calibration patches must not be touched and must not be exposed to liquids.  |
|          | Mass of the TRIOS® System incl. safe working load (in kilogram).   |
| <b>Rx</b> Only  | Prescription use only  |

## 4. Description of TRIOS

### 4.1 Certification and Compliance Notes

#### CE Mark

This product bears the CE mark in accordance with the provisions of Council Directive 93/42/EEC of June 14, 1993 concerning medical devices with amendments until 2007/47/EC, 2011/65/EEC RoHS Directive, 2005/20/EEC Packaging and Packaging Waste Directive and 2002/96/EEC Waste electrical and electronic equipment (WEEE).

|  |  |
|--|--|
|  | <b>CAUTION - EU only<br/>CE mark for connected products</b><br>Further products which are connected to this unit must also bear the CE mark. |
|--|--|

#### Compliance

This system has been tested to conform with the EN (IEC) 60601-1 Safety Standard for medical electrical devices with a Patient applied part (the standard title is: Medical electrical equipment – Part 1: General requirements for basic safety and essential performance), EN (IEC) 60601-1-1 Safety requirements for medical electrical systems, EN (IEC) 60601-1-2 Electromagnetic compatibility – Requirements and tests, and EN (IEC) 62471 Photobiological safety of lamps.

The system has also been tested to conform with CAN/CSA-C22.2 NO 60601-1 (2008) and ANSI/AAMI ES60601-1 (2005).

|   |  |
|---|--|
|  | <b>WARNING</b><br>Any person who assembles or modifies a medical electrical equipment or system complying with the standard EN (IEC) 60601-1 (safety requirements for medical electrical equipment) by combining it with other equipment is responsible for conducting appropriate inspection and testing to ensure continued safe use of the equipment and for ensuring that the requirements of this regulation are met to their full extent for the safety of the patients, the operators and the environment. Any use of accessory, transducer, or cable of the system with other equipment or systems than those specified may result in increased emissions or decreased immunity of the system. |
|---|--|

The product needs special precautions regarding EMC and needs to be installed and put into service according to the EMC information provided in the TRIOS Technical Data User Guide.

|   |   |
|---|---|
|  | <b>IMPORTANT NOTICE</b><br>The system is to be used in a Professional Healthcare Environment. |
|---|---|

### 4.2 Intended Use

The 3Shape TRIOS intraoral scanner system is an optical impression CAD/CAM system intended to obtain 3D digital images of the topographical characteristics of teeth directly from the patient’s mouth or from impressions or models of the teeth – for use with CAD/CAM dental restoration design and production of dental indications as well as with orthodontics. See the online help for a list of supported indications.

|  |   |
|--|---|
|  | <b>CAUTION</b><br>Unintended use of the TRIOS system can result in physical injury to patients, operators and damage to the system. |
|--|---|

### 4.3 Users of TRIOS

The TRIOS system may be operated only by trained dental professionals and qualified personnel. Using the TRIOS system for any purpose other than the “intended use” described above may damage the TRIOS system and harm operators and patients. Proper use of the TRIOS system includes following the operation and maintenance instructions, and observing warnings and caution descriptions in this user guide.

|   |   |
|---|---|
|  | <b>WARNING</b><br><b>Carefully follow the instructions in this guide</b><br>If the instructions for operating the TRIOS system as described in this guide are NOT observed, the intended protection and safety of the user and patient may be impaired. |
|---|---|

## 4.4 Contra-indications

None

## 4.5 Patient Target Group

No restrictions in patient population

## 4.6 System Description

The TRIOS intraoral scanner system enables trained dental professionals to obtain 3D images of the topographical characteristics of their patient's teeth directly from their mouths.

Regional variation can occur regarding the contents of the systems.

**The system is available in these variants:**

|               |   |
|---------------|---|
| <b>S1A-9</b>  | <b>Handle scanner, supplied with a MOVE® cart with built-in PC.</b>     |
| <b>S1A-10</b> | <b>Pen scanner, supplied with a MOVE cart with built-in PC.</b>         |
| <b>S1A-11</b> | <b>Handle Mono Scanner, supplied with a MOVE cart with built-in PC.</b> |
| <b>S1A-12</b> | <b>Pen Mono Scanner, supplied with a MOVE cart with built-in PC.</b>    |
| <b>S1A-21</b> | <b>Handle scanner, supplied with a MOVE+ cart with built-in PC.</b>     |
| <b>S1A-22</b> | <b>Pen scanner, supplied with a MOVE+ cart with built-in PC.</b>        |



Details are described in the following. You can find the figures in the final section of this guide.

All system variants comprise (Figure 1):

- **Handheld TRIOS intraoral scanner** (S1a or S1b) (S1-1, S1-2): Handheld dental intraoral scanner for scanning the surface of the patient's teeth. In some configurations, the scanner can scan in color.
  - **Scanner Tip** (S-tip) (S2): Re-usable scanner tip attached to the handheld TRIOS scanner. When the tip is detached, the scanner's optical window (S2) is visible.
- The scanner tip has a fixed mirror (engraved serial starting with «F», light-grey metal at the end).
- A set of scanner tips is delivered with the scanner. The scanner tip is the only applied part.
- **Protection Tip** (S-Ptip) (S3): Protects the optical window of the scanner from damage and dirt when the scanner is not in use.
  - **Calibration Tip** (S-Ctip) (S4): Used only for calibrating the scanner.
  - **Color Calibration Kit** (S-Ckit) (S5): Used for color calibrating TRIOS scanners. The kit consists of the color calibration target (S6), the color calibration adaptor (S7) and the sleeve (S8).
  - **TRIOS software**: Scan application/user interface for the scanner.
  - **Power (mains) cable and plug**: The system is delivered with a cable appropriate for your location. In the USA and Canada, this is a Nema 5-15P Hospital Grade mains power cord with plug. When the scanner tip is moved in close proximity to the teeth, a digital image of the teeth is relayed to the software and a 3D model is created in the computer. The 3D model is stored in the computer along with the patient's case information.
  - **MOVE Cart C4.0 or MOVE+ cart C4.1**,  
in this guide all information given by MOVE Cart applies for both MOVE and MOVE+ Cart (Figure 2 and Figure 3):
    - Has an adjustable monitor (S9, S10 and S11)
    - Has a scanner mount for holding the scanner while not in use.
    - Has wheels for mobility (and brakes (Figure 5) if mobility is not desired).
    - Computer Unit: Attached to the MOVE cart – for processing, storage and running the TRIOS software.
    - Touch screen: Touch-enabled screen for real-time display of scanning results generated by the TRIOS software, and for interacting with the TRIOS software.
    - The system standby button (S12) is on the top backside of the screen.
    - In the bottom (S13), there is a power socket (S14), a network (LAN) connector (S15), a fuse drawer (Figure 7), and a service USB port behind a lid.
  - **USB port**: The MOVE+ has a USB port (S21).

## 4.7 Setting up TRIOS

It is recommended that unpacking, assembly and connection of the TRIOS System is performed by TRIOS authorized technical service personnel.

|   |   |
|---|---|
|  | <b>CAUTION</b><br>If the system has just been delivered from a cold environment, let it adjust to room temperature to avoid internal condensation and to allow for proper calibration.  |
|  | <b>CAUTION</b><br>Examine all parts of the system. Look for physical damage, loose parts or signs of wear that could interfere with proper use and functionality. Contact your service provider if there is visible damage or malfunctioning. |

**Please follow the steps below for assembling TRIOS (Figure 4):**

|  |
|--|
| <b>Step 1:</b> Follow the instructions in the packaging to assemble the foot onto the MOVE cart. Tools are provided in the box.  |
| <b>Step 2:</b> Place the MOVE cart optimally in relation to the patient chair and your work position (S16).  |
| <b>Step 3:</b> Attach the protection tip to the TRIOS scanner if not already in place (S17).   |
| <b>Step 4:</b> Place the scanner on its designated scanner mount on the MOVE Cart (S18).   |
| <b>Step 5:</b> Connect the scanner cable to the scanner connection socket on the MOVE Cart behind the screen below the hinge (S19).<br>To connect - Push the plug into socket. There is a red orientation dot on the socket and plug that should match.<br>To disconnect - Pull on the outer release sleeve. |
| <b>Step 6:</b> Connect the MOVE cart end of the power cable to the socket at the bottom of the computer unit (S19).  |
| <b>Step 7:</b> Connect the power cable to a grounded power outlet. Ensure that the MOVE Cart is placed so it does not block the switch on the mains socket-outlet. To isolate the MOVE Cart and thus the scanner from supply mains, unplug the flexible power cord from mains (S20).                         |
| <b>Step 8:</b> Connect the LAN cable to the MOVE cart's LAN connection at the bottom of the computer unit (S20).   |

## 4.8 Starting and Shutting Down TRIOS

The friction of the arm that holds the scanner and display can be adjusted. Tool is provided with the system.

**Please follow the steps below to start TRIOS for the first time:**

|  |
|--|
| <b>Step 1:</b> Turn the system ON<br>S1A: Press the standby button on the top of the backside of the display. The TRIOS software starts automatically. |
| <b>Step 2:</b> Log on using a default TRIOS Operator.  |

### Step 3: Configure and use your TRIOS® system.

When using TRIOS system the user will be guided by easy-to-understand messages shown in the TRIOS software. Examples of messages include:

- When the scanner has not been calibrated for the last 8 days the user is asked: "It is 8 days since last calibration. Do you want to calibrate the scanner now?"
- When calibration is completed the user is reminded to remove calibration tip: "Ensure that the calibration tip is removed before proceeding."
- When entering the scan page the user is reminded to mount the scanner tip: "Please make sure the scanning tip is mounted on the scanner".

### Calibration

A calibration of the Handheld TRIOS scanner is required before using TRIOS for the first time and every 8 days during regular use or when the scanner has been moved or sustained hits or strong temperature changes. The calibration is done by placing the Calibration Tip on the Scanner Tube, go to the Configure page in the TRIOS software, select Scan → 3D calibrate scanner, and then follow the on-screen instructions.

For a more detailed description of the calibration please refer to the TRIOS online help.

### TRIOS Color Scanner only

#### Color Calibration

A color calibration of the handheld TRIOS Color scanner is required before each scan in order to get optimal colors.

- Attach a cleaned and sterilized scanner tip on the scanner tube.
- Remove the sleeve from the color calibration target.
- Mount the color calibration target on the color calibration adaptor with the color side facing up.
- Attach the color calibration adaptor on the cleaned and sterilized scanner tip.
- Go to the Configure page in the TRIOS software, select Scan → Color calibrate scanner, and then follow the on-screen instructions which will also include validation of the performed color calibration.

For a more detailed description of the color calibration please refer to the TRIOS online help.

#### Proper shutdown

Inside the TRIOS software click on the "Close" button and select "Shutdown" or press the standby button. The standby button turns off to confirm that the system is shut down.



|  |   |
|--|---|
|  | <b>CAUTION</b><br>When switching off the system, allow enough time for it to shut down properly before disconnecting the mains cable. |
|--|---|

|  |  |
|--|--|
|  | <b>IMPORTANT NOTICE</b><br>The standby button can also be used to force TRIOS to shut down in case the screen stops responding. To force a shutdown, push and hold the standby button pressed for about 5 seconds. Then, restart the system. |
|--|--|

## 4.9 Starting TRIOS Online Help

The TRIOS online help can be started from TRIOS software by clicking on the "Help" button and choosing "User Manual".

## 4.10 TRIOS System Environment

|   |   |
|---|---|
|  | <b>Operating Conditions</b><br>Ambient temperature range: +15 – +30°C<br>Relative humidity: 10 – 85 % (Non-condensing)<br>Atmospheric pressure: 800 – 1100hPa.<br>The scanner should be used in an environment maintaining a consistent room temperature. |
|  | <b>Storage Conditions</b><br>Ambient temperature range: -10 – +60°C<br>Relative humidity: 10 – 85 % (Non-condensing)<br>Atmospheric pressure: 800 – 1100hPa.  |
|  | <b>Transport Conditions</b><br>Ambient temperature range: -10 – +60°C<br>Relative humidity: 10 – 85 % (Non-condensing)<br>Atmospheric pressure: 620 – 1200hPa.  |

## 4.11 Technical specifications

|                                    |  |
|------------------------------------|--|
| <b>Light source specifications</b> | Do not view directly with optical instruments. The product complies with EN (IEC) 62471 (Photobiological safety of lamps and lamp systems) and UL- standard US code of federal regulations, 21 CF 1040.10 and 1040.11. |
| <b>Sterilization method</b>        | Scanner tips are autoclavable.   |
| <b>Power input</b>                 | <b>SIA MOVE cart C4.0</b><br>Power input: 100-240VAC; 50/60Hz;<br>180VA max<br>Insulation class: class I   |

## 5. Safety and Warnings

### 5.1 Prerequisites

|   |  |
|---|--|
|  | <b>CAUTION</b><br>Read all instructions carefully including all warnings and caution notices. You must comply with the warnings in this manual to prevent injury to persons and damage to equipment. Proper functionality and safety can only be guaranteed if the safety precautions in this safety guide and on the TRIOS system are observed. |
|---|--|

### Preventive inspection before use of the system

|   |   |
|---|---|
|  | <b>CAUTION</b><br>Please examine the TRIOS system for any mechanical damage on: <ul style="list-style-type: none"><li>• all enclosures</li><li>• all cables</li></ul> Safety can only be guaranteed if NO DAMAGE on the TRIOS system is observed. |
|---|---|

### Modifications of the system

**CAUTION**

Modifications of the system which may affect the safety of the operator, patients or third parties are prohibited by law!

**Approved software only****CAUTION**

Install only approved software – to prevent interference with the runtime reliability of the system and programs within it.

**Proper training****WARNING**

Before you attempt to use the TRIOS® scanner equipment with patients:

- You should be trained to use the system or have read and understood all sections of this guide describing correct operation.
- You should also be thoroughly familiar with the safe operation of the TRIOS scanner equipment as described in this documentation.

**In case of equipment failure****WARNING**

If at any time the TRIOS system malfunctions, or if you suspect in any way that the TRIOS system is not working correctly:

- Remove the scanner from contact with the patient.
- Unplug the system and make sure it cannot be used before it is checked (marking).
- Contact your reseller.
- DO NOT attempt to open any covers on the TRIOS system.

**Portable RF communications equipment****WARNING**

- Portable RF communications equipment (including peripherals such as antenna cables and external antennas) should be used no closer than 30 cm (12 inches) to any part of the MOVE® cart system, including cables specified by the manufacturer. Otherwise, degradation of the performance of this equipment could result.

**5.2 Mechanical Hazards****Fragile and movable parts****WARNING**

Be careful to avoid the following potential sources of injury:

- Do not lean or sit on any part of the system.
- Movable parts can pinch body parts.

**Dropped or damaged equipment****WARNING**

If you drop a TRIOS tip on the floor, you MUST dispose of it immediately and NOT use the same tip again for scanning. There is high risk that the mirror in the tip has become dislodged and can fall out.

**WARNING**

If the handheld scanner is dropped or bumped it should immediately be calibrated before further use. If calibration fails, please contact your technical service provider. See this guide's instructions on calibrating the handheld scanner.

**WARNING**

If the handheld scanner is dropped examine the TRIOS system for any mechanical damage. If a mechanical failure is observed or suspected treat this as an equipment failure (see this guide's instructions on handling equipment failures).

**WARNING**

- When moving the MOVE Cart across the floor, maintain all its wheels in contact with the floor and ensure that they are not locked.
- Always place the scanner in its intended mount on the MOVE Cart when not in use and when moving the MOVE Cart.
- Keep your feet clear of the MOVE Cart's base and wheels when moving the MOVE Cart.
- Never drag the MOVE Cart across any of its cables.
- Do not place the MOVE Cart on a slope greater than 10 degrees.
- Keep sharp objects away from the touch screen.

**5.3 Explosion Hazards****Environment****WARNING**

The TRIOS system is not designed to be used in environments that are potentially explosive such as in close proximity to flammable liquids or gases or in oxygen-enriched atmospheres.

**Distance to the patient****WARNING**

There is a potential explosion hazard if the TRIOS system is operated in the presence of flammable anesthetic.

**5.4 Electrical Safety****Ensure a grounded/earth connection****WARNING**

To avoid the risk of electric shock, this equipment must only be connected to a supply mains with grounding/protective earth. The system is equipped with a three pin (US: prongs) grounding/earth type plug. If you cannot insert the plug into your outlet, contact your electrician to replace the plug or outlet to ensure a grounded power connection. Do not try to defeat or ignore the purpose of the grounding-type plug.

**Electrical shock****WARNING**

There is a risk of electrical shock if you attempt to access the inside of any part of the system. Only authorized and qualified service personnel may access the inside of any part of the system.

### Do not use a power strip

|  |  |
|--|--|
|  | <p><b>WARNING</b></p> <p>Do not connect the TRIOS® to an ordinary power strip or extension cord because these may not be secure in relation to grounding. If the ground connection fails, these can cause the following hazards and potential injury:</p> <ul style="list-style-type: none"><li>• The total leakage current for all the connected equipment can exceed the limits specified in EN/IEC 60601-1.</li><li>• The impedance of the ground connection could exceed the limits specified in EN/IEC 60601-1.</li></ul> |
|--|--|

### Stress on cables

|  |   |
|--|---|
|  | <p><b>CAUTION</b></p> <p>All externally connected cables such as power cable, network cable, and the hand-held scanner cable connection, must never be subjected to pulling stress.</p> |
|--|---|

### Spilled liquids

|  |  |
|--|--|
|  | <p><b>WARNING</b></p> <p>Do not bring liquids such as beverages near the TRIOS system. Do not spill liquids on the TRIOS system.</p> |
|--|--|

### Condensation

|  |  |
|--|--|
|  | <p><b>WARNING</b></p> <p>Variations in temperature or humidity may cause water to condense inside the system which can cause it damage. Always let the system reach room temperature before you plug it in to the power source.</p> <p>If the system has been subject to major temperature or humidity changes, wait at least 2 hours before plugging it in to the power source.</p> <p>If there is visible evidence of condensation, wait at least 8 hours before plugging it in to the power source.</p> |
|--|--|

### Disconnecting from mains

|   |   |
|---|---|
|  | <p><b>WARNING</b></p> <p>There is no power ON/OFF switch on the system therefore the only reliable means to disconnect the system from mains is to unplug the power cord. Do not position the system so that it is difficult to unplug the power cord. Please allow enough time for the system to shut down properly before disconnecting the power cord.</p> |
|---|---|





### USB service connection options and requirements

|  |  |
|--|--|
|  | <p><b>WARNING</b></p> <p>Only connect bus-powered USB devices without external power supply.</p> |
|--|--|

## 5.5 Eye safety





|   |  |
|---|--|
|  | <p><b>WARNING</b></p> <p>The scanner emits bright light from its tip during operation. The scanner complies with EN (IEC) 62471 (Photobiological safety of lamps and lamp systems). However, we recommend caution when handling the scanner.</p> <p>A brief glimpse of the light into the eye is not dangerous, but do not stare into beam or view directly with optical instruments and do not aim the beam towards other people's eyes. In general, intense light sources have a high secondary exposure potential due to their blinding effect. As is also true when viewing other bright light sources (e.g. headlights), temporary reduction in visual acuity and afterimages can occur, leading to irritation, annoyance, visual impairment, and even accidents, depending on the situation.</p> |
|---|--|

## 5.6 Hygiene

|   |   |
|---|---|
|    | <p><b>WARNING</b></p> <p>To maintain a clean work environment and the safety of the patient, wear clean surgical gloves when:</p> <ul style="list-style-type: none"><li>• Handling the scanner tip – changing the tip or setting/flipping for upper/lower scans or handling the mirror.</li><li>• Handling the protection tip.</li><li>• Handling the color calibration kit.</li><li>• Applying the TRIOS for scanning patients.</li><li>• Touching the TRIOS system.</li></ul> |
|    | <p><b>WARNING</b></p> <p>Always clean the scanner unit and its optical window before attaching the protection tip. Do not allow patient contact with the protection tip.</p>  |
|    | <p><b>WARNING</b></p> <p>Always have the scanner-tip mounted when inserting the scanner into the patient's mouth or in any way in contact with the patient. Mounting of the scanner tip is always required for maximal electrical safety and due to the risk of contamination.</p>  |
|  | <p><b>WARNING</b></p> <p>Always have a cleaned and sterilized scanner tip mounted before attaching the color calibration adaptor. Do not allow patient contact with the color calibration kit.</p>  |
|  | <p><b>WARNING</b></p> <p>Before each patient, you must:</p> <ul style="list-style-type: none"><li>• disinfect the system</li><li>• apply a new sterilized or high-level disinfected tip to the scanner</li></ul> <p>See the detailed instruction in the chapter below.</p>  |



## 5.7 Safety when scanning with TRIOS

|  |  |
|--|--|
|  | <p><b>CAUTION</b></p> <p>The handheld scanner is a highly precise optical instrument and must be handled carefully. Do not drop, shake or bump the handheld scanner as these actions could cause it to break or malfunction. Follow these guidelines:</p> <ul style="list-style-type: none"> <li>• Always return the handheld scanner to its mount when not in use.</li> <li>• Do not bend or kink the cord attached to the handheld scanner.</li> <li>• Do not submerge the handheld scanner in any liquids.</li> <li>• Do not place the handheld scanner on heated or wet surfaces.</li> <li>• Grip the handheld scanner firmly during scanning and when removing/returning to its mount.</li> </ul> |
|  | <p><b>NOTICE</b></p> <p>The scanner will get warm during use. This is normal but not part of any patient treatment.</p>  |
|  | <p><b>CAUTION</b></p> <p>The handheld scanner tip is fragile and contains a delicate mirror. To avoid damage to the tip and mirror, take care not to bump the tip onto the patient's teeth or restorations.</p>  |
|  | <p><b>CAUTION</b></p> <p>When the TRIOS system is used for pediatric patients please pay extra attention while scanning the patient.</p>   |

## 5.8 Protection from overheating

|  |   |
|--|---|
|  | <p><b>WARNING</b></p> <p>Ventilation openings must never be blocked or obstructed. There are openings at the back of the display. At the top and bottom of the computer unit. If overheated, the system may stop functioning.</p> |
|--|---|



## 6. Cleaning, Disinfection, and Sterilization

### 6.1 Cleaning, disinfecting and sterilizing the scanner tip

The TRIOS® scanner tip is the part of the scanner that is inserted into the patient's mouth during scanning. The tip can be reused a limited number of times, but it must be cleaned and sterilized between patients to avoid cross contamination.

The tip can be removed by pulling it away from the scanner body.

#### Cleaning and sterilization procedure

|  |  |
|--|--|
|  | <p><b>Step 1:</b> Clean the tip manually using soap water and a brush immediately after use. A mild dishwashing detergent or similar is recommended. Inspect the mirror of the tip after cleaning. If the mirror appears with stains, smudged or with a milky haze, repeat cleaning using a soft dish-brush and soap water. Rinse with water. Dry the mirror carefully with a paper towel.</p> |
|  | <p><b>Step 2:</b> Put the tip in a steam pouch suitable for sterilization. The pouch should be sealed. Use either a self-adhesive pouch or heat-sealed pouch.</p>  |

**Step 3:** Sterilize the wrapped tip in an autoclave with one of the two programs:

- At 134°C (273.2°F) for a minimum of 4 minutes.
- At 121°C (249.8°F) for a minimum of 45 minutes.

Use an autoclave program that dries the wrapped tip before opening the autoclave.







#### Cleaning and high-level disinfection procedure





**Step 1:** Clean the tip manually using soap water and a brush immediately after use. A mild dishwashing detergent or similar is recommended. Inspect the mirror of the tip after cleaning. If the mirror appears with stains, smudged or with a milky haze, repeat cleaning using a soft dish-brush and soap water. Rinse with water. Dry the mirror carefully with a paper towel.

**Step 2:** Disinfect the tip using Wavicide-01 Solution. Immerse the tip completely in Wavicide-01 for 45 to 60 minutes. See also the Wavicide-01 Solution Instructions for Use.

**Step 3:** Rinse the tip. After having been immersed in the Wavicide-01 Solution for 45 to 60 minutes remove the tip and rinse it according to the Wavicide-01 Solution Instructions for Use.

**Step 4:** Dry the tip. Use a sterile and non-abrasive paper towel or cloth to gently remove remaining drops on the mirror and to dry the tip.





|   |   |
|---|---|
|    | <p><b>CAUTION</b></p> <p>The mirror in the tip is a delicate optical component. Its clean and undamaged surface is critical for the scan quality. The mirror should be handled with care. Do not scratch it. Be careful not to smudge it before scanning a patient.</p> |
|    | <p><b>CAUTION</b></p> <p>Always clean the tip immediately after use. If biological materials (bioburden) are allowed to dry on equipment, disinfection and sterilization processes may not be effective.</p>  |
|   | <p><b>CAUTION</b></p> <p>Never autoclave a tip that is not wrapped, since this will leave stains on the mirror that cannot be removed. See the autoclave manual for more information.</p>   |
|  | <p><b>CAUTION</b></p> <p>New tips must be cleaned and sterilized / autoclaved before using them for the first time.</p>   |
|  | <p><b>CAUTION</b></p> <p>A class B Vacuum autoclave according to EN13060 is required for sterilization of the scanner tip.</p>  |
|  | <p><b>CAUTION</b></p> <p>The scanner tip with fixed mirror can be re-sterilized up to 150 times and must be disposed afterwards as described in section 7. Disposal.</p>  |
|  | <p><b>CAUTION</b></p> <p>The scanner tip with fixed mirror can be high-level disinfected up to 150 times with Wavicide-01 Solution and must be disposed afterwards as described in section 7. Disposal.</p>   |

|  |   |
|--|---|
|  | <b>CAUTION</b><br>When high-level disinfecting the scanner tip with fixed mirror using Wavicide-01 Solution there may be a visual change to the tip after 70 disinfections. This change is only visual and does not pose a risk.  |
|  | <b>IMPORTANT NOTICE</b><br>High-level disinfection by Wavicide-01 Solution as an alternative to sterilization has been validated by 3Shape. The Wavicide-01 Solution is not allowed and/or recognized as a disinfectant of medical devices worldwide, always follow procedures that have been established for your clinic or institute, as well as any national guidelines. |
|  | <b>IMPORTANT NOTICE</b><br>Always follow cleaning, disinfection and sterilization procedures that have been established for your clinic or institute, as well as national guidelines.   |
|  | <b>IMPORTANT NOTICE</b><br>If using Wavicide-01 for high-level disinfection be sure to follow the Wavicide-01 Solution Instructions fUse.   |

## 6.2 Cleaning, disinfecting and sterilizing the Color Calibration Kit

The TRIOS® color calibration adaptor must always be attached on a cleaned and sterilized scanner tip and must not have contact to patients. If these instructions are not followed the color calibration kit must be cleaned, disinfected and sterilized.

### Cleaning, disinfection and sterilization procedure

|  |  |
|--|--|
|    | <b>Step 1:</b> Disassemble the color calibration kit (remove the sleeve from the color calibration target and disassemble the color calibration target and the color calibration adaptor).   |
|    | <b>Step 2:</b> Clean the color calibration adaptor manually using soap water and a brush. Sterilize the cleaned color calibration adaptor in an autoclave using one of the programs listed for the scanner tip and using a steam pouch suitable for sterilization. |
|  | <b>Step 3:</b> Clean the sleeve manually using soap water and a brush. Disinfect the sleeve using the recommended disinfection solution listed in section 6.3 Cleaning and disinfecting other parts of the system.   |
|  | <b>Step 4:</b> The color calibration target must only be cleaned with air. The calibration patches must not be touched and must not be exposed to liquids. See the important notice below.   |

After cleaning, disinfection, and sterilization, the color calibration kit must be reassembled before use. Ensure that all parts are dry before reassembly. If the kit is not used immediately, place the color calibration target in the sleeve and leave the color calibration adaptor in the sterilization pouch.

|  |  |
|--|--|
|  | <b>IMPORTANT NOTICE</b><br>The color calibration target is a delicate optical component. During disassembly and assembly of the color calibration kit only the end-part of the color calibration target (opposite of the calibration patches) must be touched, and the target must only be cleaned with air. |
|--|--|

## 6.3 Cleaning and disinfecting other parts of the system



After patient treatment, clean and disinfect all other surfaces of the system (except the scanner tip and color calibration kit, for which the previous sections apply). Also note that the optical window is a delicate optical component and should be handled with extra care during cleaning and disinfection (see below).







For general cleaning, a soft cloth and a mild detergent can be used.

### Recommended disinfection solution:

Denatured alcohol (IPA – Isopropyl Alcohol or Ethanol) – typically 60-70% Vol.



### To disinfect:

|   |   |
|---|---|
|  | <b>Step 1:</b> Apply the disinfection solution to a soft lint-free non-abrasive cloth, the cloth must only be damp.             |
|  | <b>Step 2:</b> Wipe the surfaces with the damp cloth.   |
|  | <b>Step 3 (optical window on scanner only):</b> Dry the optical window with another clean, soft, lint-free, non-abrasive cloth. |

|   |   |
|---|---|
|    | <b>CAUTION</b><br>The scanner's optical window is a delicate optical component. Its clean and undamaged surface is critical for the scan quality. The window should be handled with care. Make sure it is free from lint, stains, and other kind of dirt.         |
|    | <b>CAUTION</b><br>Never submerge the TRIOS scanner into the cleaning solution.  |
|    | <b>CAUTION</b><br>Do not use ammonia-based or chloride based solutions or acetone on any surface. Before returning the scanner to its holder, ensure both are dry.  |
|    | <b>CAUTION</b><br>Do not spray directly onto the monitor, as the liquid solution can accumulate at the seals and leak into the monitor.   |
|   | <b>NOTICE</b><br>The scanner shell might get yellow-toned over a long period of use.  |
|  | <b>IMPORTANT NOTICE</b><br>All surfaces that the protection and/or calibration tip comes in contact with, particularly the scanner tube and its optical window, must always be cleaned and disinfected before attaching the protection tip / the calibration tip. |

## 6.4 Additional cleaning if you see poor scan quality

During scanning the tip mirror may become unclean, resulting in a loss of scan quality. In this situation, you can clean the mirror following these steps:

|   |  |
|---|--|
|  | <b>Step 1:</b> Remove the scanner tip.   |
|  | <b>Step 2:</b> Apply alcohol to a clean cloth or cotton-tipped swab and wipe the tip mirror until it is clean. Use alcohol that is free of impurities, as those may stain the mirror. Ethanol or propanol (ethyl-/propyl alcohol) can be used. |
|  | <b>Step 3:</b> Wipe the tip mirror dry with a dry, lint-free cloth to avoid leaving dust and fiber on the mirror.  |

**CAUTION**

Do not use acetone or any oxidizing solutions to clean the tip mirror.

If you still see problems, check the scanner's optical window for cleanliness, and apply the same procedure if necessary.

## 7. Disposal

### 7.1 Disposal of the scanner tip

Sterilize the tip as described above.

The scanner tip can then be disposed normally as other clinical waste.

**CAUTION**

Dispose the scanner tip as other clinical waste.

**CAUTION**

The scanner tip must be sterilized before disposal.

### 7.2 Disposal of the TRIOS System

For disposal of the TRIOS® System please contact your 3Shape reseller who can inform you about the local requirements for disposal of electronic waste.

## 8. Technical Maintenance

**CAUTION**

All technical service and repair of the TRIOS System must be performed by 3Shape or 3Shape-authorized personnel only.

The user need not perform any regular maintenance other than calibration and cleaning, disinfection and sterilization as described here. Preventive inspections and scheduled maintenance are not required.

### Changing the fuses (Figure 6):

Shut down the Trios MOVE® cart by following the procedure described in section 4.6 Starting and Shutting Down TRIOS and disconnect the mains power cable from the Trios MOVE cart.

**WARNING**

The mains power cable must be disconnected before changing fuses.

Using a pair of tweezers or similar, push in the two tabs on each side of the fuse drawer simultaneously as shown in the picture, and the drawer will begin to emerge from its slot.

It is then possible to remove the drawer and replace the two fuses. Two spare fuses are provided with the system on delivery.

**WARNING**

Only fuses with the correct rating and type (250V, T3.15A H) must be used.

To replace the fuses, first mount them in the drawer, then insert the drawer back into the slot and push all the way in until the tabs click back into place and the drawer is no longer loose in the slot. Do not attempt to insert the fuses directly into the slot on the MOVE cart.

The mains cable can now be reconnected and the TRIOS MOVE cart system started up.

### Changing the dongle (software license protection (Figure 7):

The dongle is located behind a plastic lid on the top of the backpack of the MOVE cart.

**WARNING**

The scanner must not be operated while the lid on the back side of the MOVE Cart is removed.

## 9. Environmental Considerations

3Shape recognizes our common responsibility for the Earth. Thus the TRIOS system is designed to conform with the following directives.

RoHS, Restriction of the Use of Certain Hazardous Substances in Electrical and Electronic Equipment (2002/95/EC).

WEEE, Waste Electrical and Electronic Equipment Directive (2002/96/EC).

## 10. Consumable Accessories

The only consumable accessories to the TRIOS System are the scanner tips and the color calibration kit.

When the scanner tips are disposed new tips can be ordered by contacting your 3Shape reseller. Also, a new color calibration kit can be ordered from your 3Shape reseller.

## 11. Vigilance

It is of vital importance that 3Shape is informed of all incidents which have caused, or may have caused/contributed to, a death or serious injury on persons (patients or users/operators) through the use of a 3Shape product.

In such cases please escalate the case to 3Shape Support via email ([support@3shape.com](mailto:support@3shape.com)) or by calling 3Shape's local support team.

## 12. Sponsors

Australian Sponsor

Emergo (Australia), Level 20, Tower II  
Darling Park, 201 Sussex Street  
Sydney, NSW 2000, Australia

Tel: +61 2 9006 1662

# Inhaltsverzeichnis – TRIOS 3 MOVE+ Sicherheits- und Bedienungshandbuch

|  |    |
|--|----|
| 1. Sehr geehrte Kunden                       | 3  |
| 2. Konformität                               | 3  |
| 3. Allgemeine Informationen                  | 3  |
| 4. Beschreibung von TRIOS                    | 4  |
| 5. Sicherheitshinweise und Warnungen         | 7  |
| 6. Reinigung, Desinfektion und Sterilisation | 9  |
| 7. Entsorgung                                | 11 |
| 8. Technische Wartung                        | 12 |
| 9. Umweltschutz                              | 12 |
| 10. Verbrauchsartikel                        | 12 |
| 11. Beobachtungs- und Meldesystem (Vigilanz) | 12 |

## 1. Sehr geehrte Kunden

Vielen Dank, dass Sie sich für das **TRIOS®-System** von 3Shape TRIOS entschieden haben.

Mit dem TRIOS-System können Sie Oralscans von den Zähnen Ihrer Patienten aufnehmen, digital speichern und in CAD/CAM-Dentalsystemen weiterverwenden.

Das vorliegende Sicherheits- und Installationshandbuch enthält Sicherheitsvorkehrungen, Warnungen und Hinweise zum TRIOS System. Die schrittweisen Anleitungen zur Konfiguration und dem Betrieb Ihres TRIOS-Systems finden Sie in der Online-Hilfe.

Vor der Montage oder der Inbetriebnahme von TRIOS lesen und beachten Sie die Anweisungen in diesem Sicherheits- und Bedienungshandbuch sowie im Online-Hilfesystem. Bewahren Sie dieses Sicherheits- und Bedienungshandbuch immer griffbereit in der Nähe des Systems auf.

Beachten Sie alle sicherheitsbezogenen Informationen und Warnungen, um Verletzungen von Personen, Materialbeschädigungen oder eine Beschädigung des TRIOS-Systems zu vermeiden.

Vielen Dank,  
3Shape TRIOS A/S

## 2. Konformität

Dieses Handbuch wurde von 3Shape TRIOS A/S veröffentlicht. 3Shape TRIOS A/S behält sich das Recht vor, den Inhalt dieses Dokumentes ohne vorherige Ankündigung zu verbessern und zu ändern. Änderungen werden jedoch in zukünftigen Ausgaben veröffentlicht. Alle Rechte vorbehalten.

TRIOS ist eine Handelsmarke von 3Shape TRIOS A/S.

Produkte werden von 3Shape TRIOS A/S, Holmens Kanal 7, 1060 Kopenhagen K, Dänemark hergestellt.

### Konformitätserklärung (EU):

3Shape TRIOS A/S erklärt hiermit, dass das TRIOS-System die folgenden Bestimmungen einhält: MDD 93/42/EWG mit Ergänzungen bis Richtlinie 2007/47/EG, RoHS-Richtlinie 2011/65/EU, Richtlinie 2005/20/EG über Verpackungen und Verpackungsabfälle und Richtlinie 2002/96/EG über Elektrik- und Elektronikaltgeräte (WEEE). Darüber hinaus ist es konform mit den folgenden Standards: EN (IEC) 60601-1, EN (IEC) 60601-1-1, EN (IEC) 60601-1-2, EN (IEC) 62471.

## 3. Allgemeine Informationen









|   |  |
|---|--|
|  | <p><b>ACHTUNG</b><br/><b>Stellen Sie sicher, dass Sie alle Warnungen gelesen haben!</b></p> <p>Beachten Sie alle sicherheitsbezogenen Informationen und Warnungen, um Personen- oder Materialschäden oder eine Beschädigung Ihres TRIOS-Systems zu vermeiden. Sicherheitsbezogene Informationen und Warnungen sind im vorliegenden Handbuch mit den Worten <b>WARNUNG</b>, <b>ACHTUNG</b> oder <b>HINWEIS</b> hervorgehoben.</p> |
|---|--|

### 3.1 Zu diesem Dokument - Symbole

In diesem Handbuch werden die folgenden Symbole verwendet:

|   |   |
|---|---|
|  | <p><b>WARNUNG</b></p> <p>Warnungen beziehen sich auf Situationen, in denen ein mittleres Risiko für Personenschäden besteht, falls Hinweise nicht beachtet werden.</p>  |
|  | <p><b>ACHTUNG</b></p> <p>Sicherheitsrelevante Informationen zur Vermeidung von Gefahren: Eine Nichtbeachtung der Hinweise birgt eine geringe Gefahr von Personenschäden, die Gefahr eines Sachschadens und/oder kann eine Beschädigung des Systems zur Folge haben.</p> |
|  | <p><b>WICHTIGER HINWEIS</b></p> <p>Ein wichtiger Hinweis, welcher kein Warn-/Achtungshinweis ist, aber unbedingt befolgt werden muss.</p>   |
|  | <p><b>TIPPS</b></p> <p>Hinweise, Tipps, zusätzliche Informationen dienen der Unterstützung des optimalen Betriebs Ihres Systems.</p>  |

### 3.2 Erläuterung der Aufkleber und Symbole

|   |  |
|---|--|
|   | Herstellungsjahr (EN/ISO 15223-1)                              |
|  | Unternehmen und Adresse (EN/ISO 15223-1)                       |
|  | Allgemeine Warnung - Achtung (ISO 7010-W001, schwarz auf gelb) |
|  | Gerätetyp: Typ BF (IEC 60417-5333)                             |
|  | WEEE-Produktentsorgungssymbol (Richtlinie 2002/96/EG)          |
|  | Achtung (ISO 7000-0434A)                                       |
|  | CE-Kennzeichnung   |
|  | Chargennummer  |

1

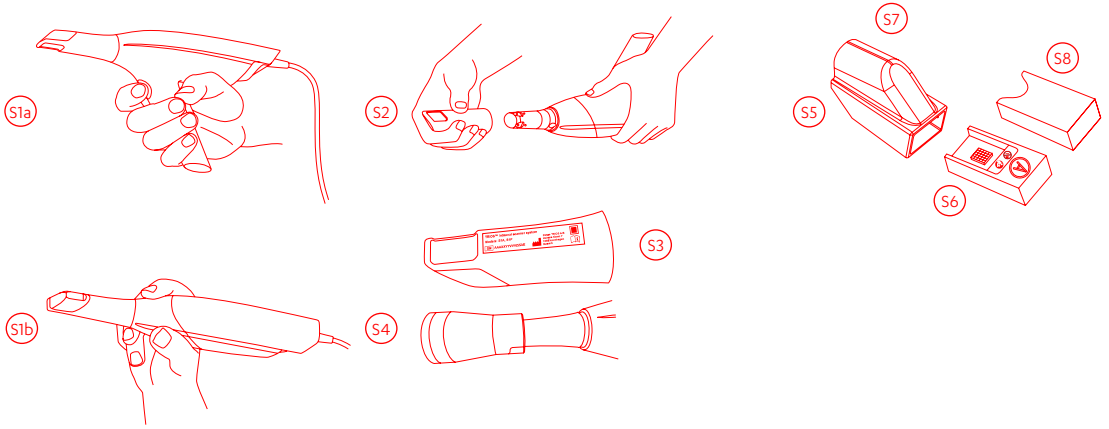

2

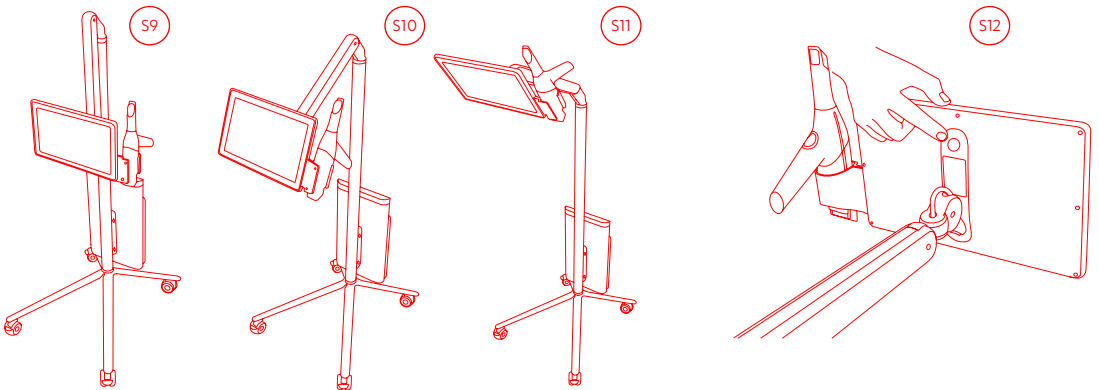

3

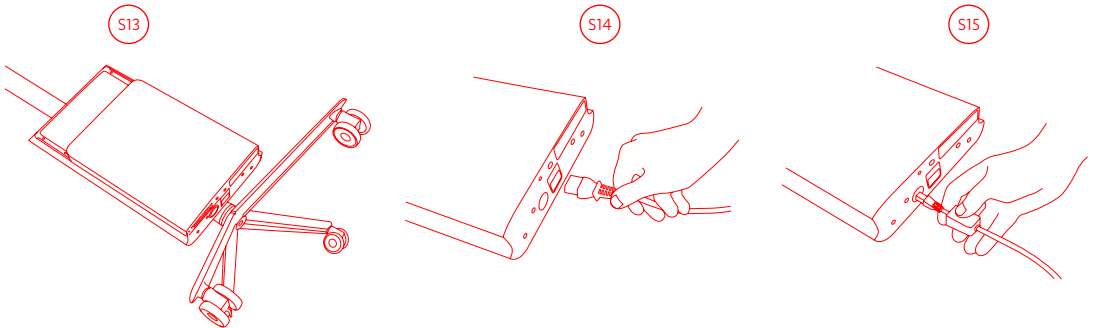

4

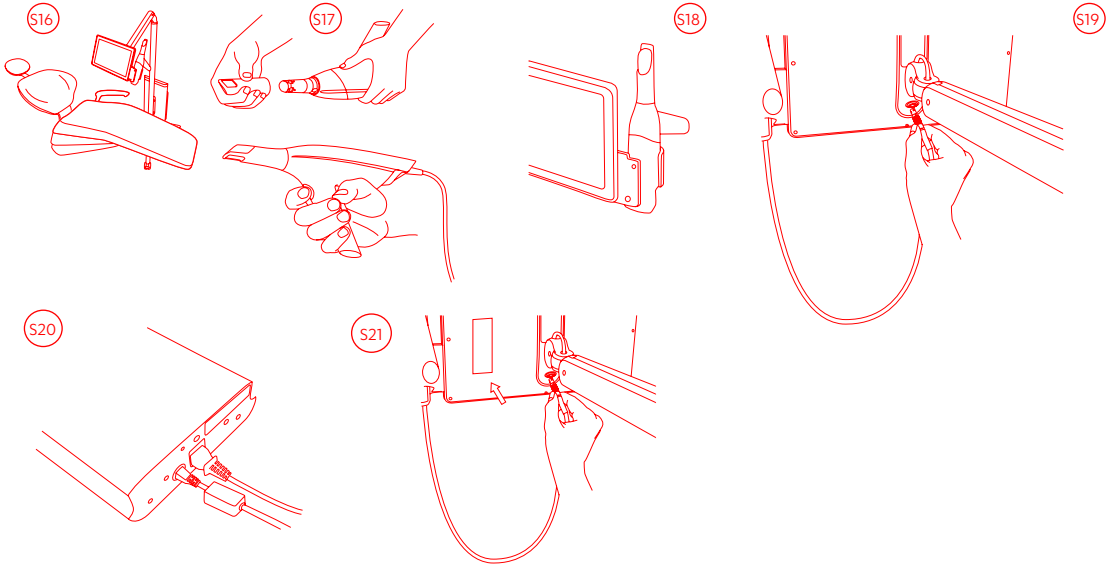

5

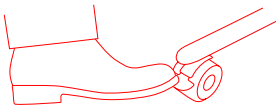

6

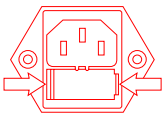

7

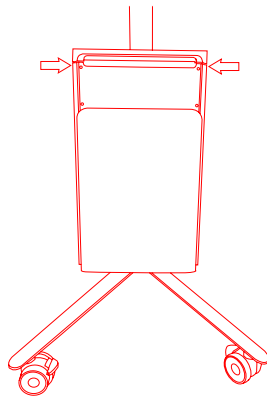

Notes:

---

---

---

---

---

---

---

---

---

---

---

---

---

---

---

---

---

---

---

---

---

---

---

---

---

---

Notes:

---

---

---

---

---

---

---

---

---

---

---

---

---

---

---

---

---

---

---

---

---

---

---

---

---

---



Let's change dentistry

More information at [www.3Shape.com](http://www.3Shape.com)